

CONCORDE

EMMANUEL GALLINA (2009)



DESCRIPTION

A design able to propose a primary shape, emphasizing the naturalness of the wood for Concorde table by Emmanuel Gallina. Soft shapes interpreted with essential style.

Poliform

CONCORDE

EMMANUEL GALLINA (2009)

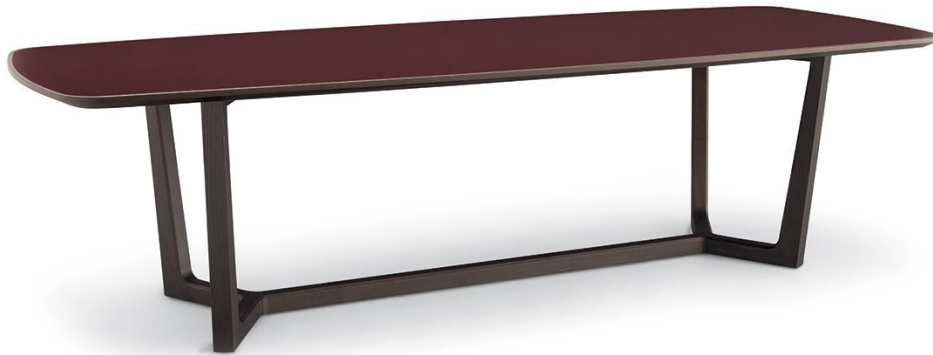

TECHNICAL DESCRIPTION

TYOLOGY

fixed table

TOP

middle-density fibre panel thickness 25 mm veneered marble or glass

Legs

solid wood

CONCORDE

EMMANUEL GALLINA (2009)

TCN218

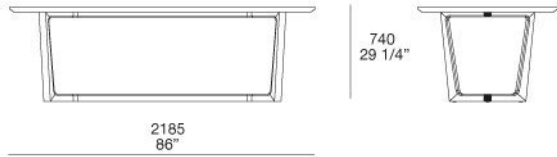

TCN240

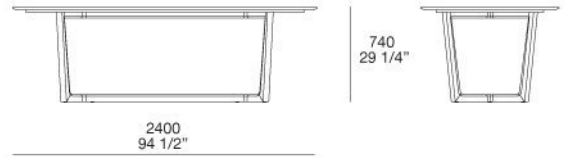

TCN280

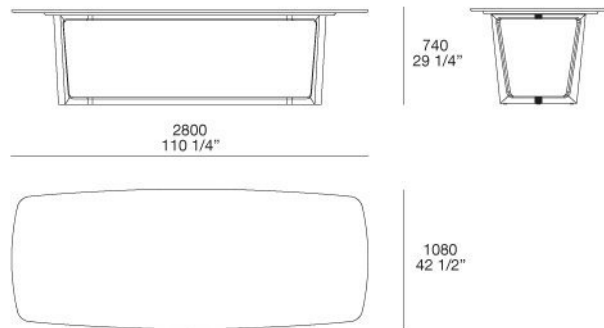

TCN140R

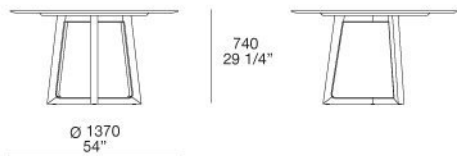

**TCN180R
PG090**

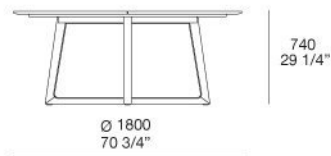

**TCN200R
PG105**

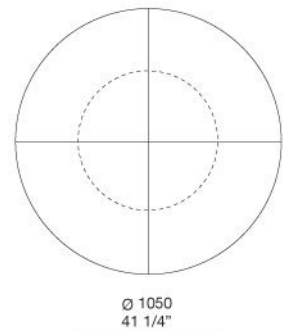
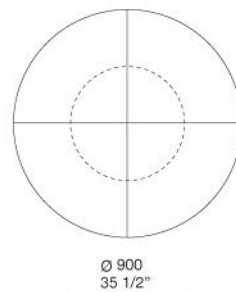
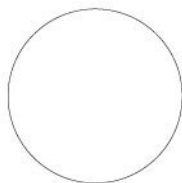
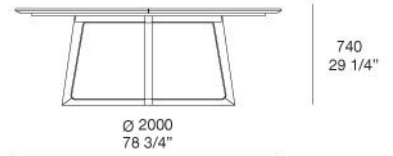

CONCORDE

FINISHINGS\TOP\MARBLE (11)

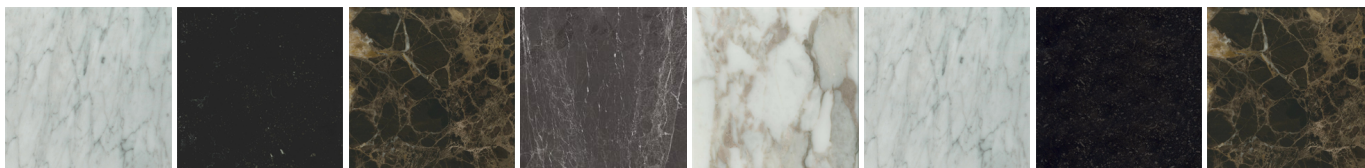

MATT
BIANCO
CARRARA

MATT PETIT
GRANIT

MATT
EMPERADOR

MATT GREY
STARDUST

MATT
CALACATTA
ORO

GLOSSY
BIANCO
CARRARA

GLOSSY
PETIT
GRANIT

GLOSSY
EMPERADOR

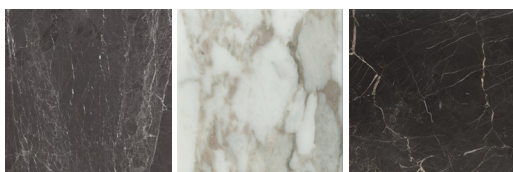

GLOSSY
GREY
STARDUST

GLOSSY
CALACATTA
ORO

GLOSSY
NOIR SAINT
LAURENT

CONCORDE

FINISHINGS\TOP\REFLECTING GLASS (1)



5010 BLUE

CONCORDE

FINISHINGS\TOP\VETRO CONCORDE (4)



2273
GHIACCIO
GLOSSY

1264 ARENA
GLOSSY

1204
GRAFITE
GLOSSY

2259
BORDEAUX
GLOSSY

CONCORDE

FINISHINGS\TOP\WOODS (4)

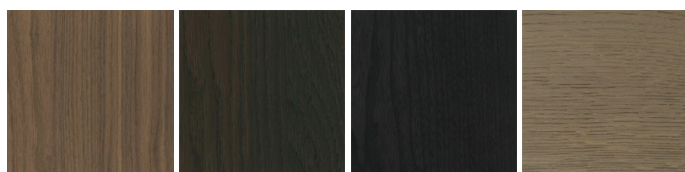

WALNUT C.

SPESSART
OAK

BLACK ELM

CENERO OAK

CONCORDE

FINISHINGS\STRUCTURE\WOODS (3)

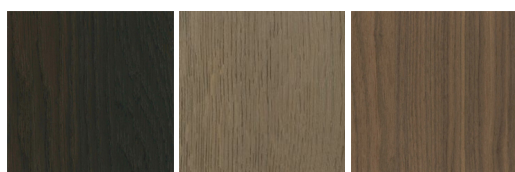

SPESSART
OAK

CENERO OAK

WALNUT C.

CONCORDE

FINISHINGS\STRUCTURE\WOODS (1)

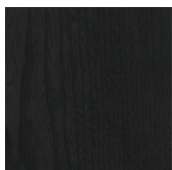

BLACK ELM