

Poliform

# ALEA PRO

KITCHENS

# Poliform

ALEA PRO KITCHEN  
DIGITAL CATALOGUE

Restyling dello storico e consolidato modello Alea, Alea Pro si caratterizza per l'espressività più marcata. Il design lineare del sistema originario è stato reinterpretato alla luce di una ridefinizione dei dettagli, in particolare delle gole di apertura, sottolineate da una sagoma che evidenzia le linee verticali e orizzontali. Nuovo è il disegno dell'anta con bordo superiore rastremato e profilo maniglia abbinato alla sagoma, così come il particolare del fianco distanziato, che dà un aspetto più leggero alle basi. Le ante vetrina per basi, pensili e colonne creano giochi di trasparenze che danno ritmo alla composizione. Il risultato è un sistema cucina che unisce all'altissima capacità operativa un aspetto contemporaneo, da personalizzare con una vastissima gamma di materiali e finiture.

A restyling of the iconic and consolidated Alea model, Alea Pro is characterized by the most marked expressiveness. The linear design of the original system has been reinterpreted in light of a redefinition of the details, in particular of the opening grooves, underlined by a profile that highlights the vertical and horizontal lines. The door design with a chamfered upper edge upper edge and handle profile matched to the profile is new, as is the detail of the spaced side panel, which gives a lighter look to the base units. The display doors for base units, wall units, and tall units create plays of transparency that give rhythm to the composition. The result is a kitchen system that combines a very high operational capacity with a contemporary look, to be customized with a very wide range of materials and finishes.

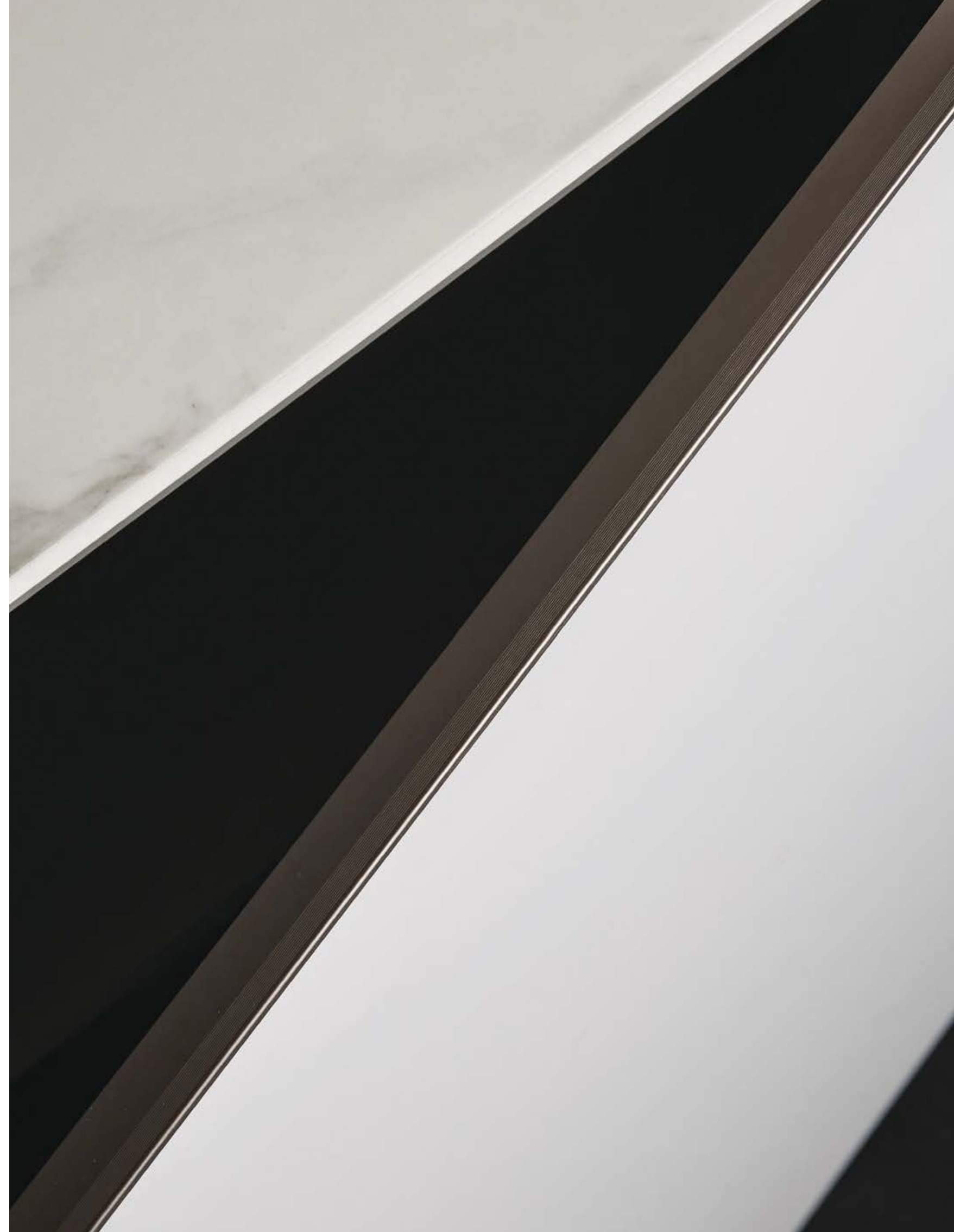













Qui e nelle pagine precedenti: isola centrale con ante in LCT super white con profilo maniglia e sagoma in anodizzato champagne, piano a sbalzo Planar in Inalco MDi® calacatta oro touch. Sgabelli Ventura in olmo nero con seduta rivestita in pelle non sfoderabile Silk 10 terracotta. Basi a parete con ante, cassetti ed estrattori in STM champagne, top e fianchi di finitura in laminato tuttocolore touch super white. Pensili con ante vetrina PR24 in anodizzato champagne e vetro riflettente fumé, struttura in nobilitato olmo smoke e illuminazione a led integrata. Sotto ai pensili, Deep Shaker in anodizzato moka e schienali in nobilitato olmo smoke. Sistema modulare Infinity personalizzato Poliform con modulo aspirante luminoso in acciaio scotch brite. Colonne con ante ed estrattori in STM champagne con profilo maniglia e sagoma in anodizzato champagne.

Here and previous pages: central island with doors in LCT super white with handle profile and profile anodized champagne, jutting-out top Planar in Inalco MDi® calacatta oro touch. Ventura stools in black elm with seat covered in non-removable leather Silk 10 terracotta. Wall base units with doors, drawers and pull-out baskets in STM champagne, top and finishing sides in laminate tuttocolore touch super white. Wall units with showcase doors PR24 in anodized champagne and fumé reflecting glass, structure in smoke elm melamine and integrated led lighting. Under the wall units, Deep Shaker in anodized moka and backs in smoke elm melamine. Poliform personalized modular system Infinity with lighted suction module in steel scotch brite. Tall units with doors and pull-out baskets in STM champagne with handle profile and profile in anodized champagne.







Qui e nella pagina precedente: pensili con ante vetrina PR24 in anodizzato champagne e vetro riflettente fumé, struttura in nobilitato olmo smoke e ripiani in vetro fumé con telaio in anodizzato nero, illuminazione a led integrata. Sotto ai pensili, Deep Shaker in anodizzato moka e schienali in nobilitato olmo smoke con ante a ribalta in laccato goffrato moka, cassettoni in noce canaletto e barattoli in ceramica e vetro con coperchi in noce canaletto. Nella precedente: basi a parete con ante ed estrattori in STM champagne, top e fianchi di finitura in laminato tuttocolore touch super white. Isola centrale con piano a sbalzo Planar in Inalco MDi® calacatta oro touch con sagoma in anodizzato champagne.

Here and previous page: wall units with showcase doors PR24 in anodized champagne and fumé reflecting glass, structure in smoke elm melamine and shelves in fumé glass with frame in anodized black, integrated led lighting. Under the wall units, Deep Shaker in anodized moka and backs in smoke elm melamine with flap doors in moka embossed lacquer, small drawers in walnut canaletto and ceramic and glass jars with walnut canaletto lids. Previous page: wall base units with doors and pull out baskets in STM champagne, top and finishing sides in laminate tuttocolore touch super white. Central island with jutting-out top Planar in Inalco MDi® calacatta oro touch with profile in anodized champagne.





A destra: dettaglio dello schienale modulare Deep Shaker in anodizzato moka e schienali in nobilitato olmo smoke con la configurazione a ponte prevista per gli elettrodomestici. Lavello integrato in acciaio per piano in laminato tuttocolore touch super white. Sotto: dettaglio Deep Shaker in anodizzato moka e nobilitato olmo smoke con anta a ribalta in laccato goffrato moka attrezzata con porta spezie, barattoli in ceramica e vetro con coperchi in noce canaletto.

To the right: close up of the modular back Deep Shaker in anodized moka and backs in smoke elm melamine with bridge configuration foreseen for electrical appliances. Integrated steel sink for top in laminate tuttocolore touch super white. Below: close up of Deep Shaker in anodized moka and smoke elm melamine with flap door in moka embossed lacquer accessorized with spice holders, ceramic and glass jars with walnut canaletto lids.









Qui e nella pagina precedente: isola centrale con ante in LCT super white, piano a sbalzo Planar in Inalco MDi® calacatta oro touch. Sgabello Ventura in olmo nero e pelle non sfoderabile Silk 10 terracotta. Basi a parete in STM champagne con top e fianchi di finitura in laminato tuttocolore touch super white, piani cottura a induzione e a gas Pitt Cooking® con manopola personalizzata Poliform. Sistema modulare Infinity personalizzato Poliform con modulo aspirante luminoso in acciaio scotch brite. A destra: dettaglio degli estrattori con cassetti interni in alluminio anodizzato naturale, attrezzatura in noce canaletto e anodizzato moka. Sotto: dettaglio del piano a sbalzo Planar in Inalco MDi® calacatta oro touch con sagoma in anodizzato champagne e fianco interno Ala in laccato opaco champagne.

Here and previous page: central unit with doors in LCT super white, jutting-out top Planar in Inalco MDi® calacatta oro touch. Ventura stool in black elm and non-removable leather Silk 10 terracotta. Wall base units in STM champagne with top and finishing sides in laminate tuttocolore touch super white, induction and gas hobs Pitt Cooking® with Poliform personalized control knob. Poliform personalized modular system Infinity with lighted suction module in steel scotch brite. To the right: close up of the pull-out baskets with inner drawers in natural anodized aluminium, equipment in walnut canaletto and anodized moka. Below: close up of the jutting-out top Planar in Inalco MDi® calacatta oro touch with profile in anodized champagne and inner side Ala in champagne mat lacquer.







In questa pagina: colonne con ante ed estrattori in STM champagne con profilo maniglia, sagoma e distanziali in anodizzato champagne. Isola centrale con ante in LCT super white con profilo maniglia e sagoma in anodizzato champagne, top in Inalco MDi® calacatta oro touch.

This page: tall units with doors and pull-out baskets in STM champagne with handle profile, profile and spacers in anodized champagne. Central island with doors in LCT super white with handle profile and profile in anodized champagne, top in Inalco MDi® calacatta oro touch.



A destra: dettaglio dell'anta in LCT super white con profilo maniglia, sagoma e distanziatore verticale terminale in anodizzato champagne. Top e fianchi di finitura in Inalco MDi® calacatta oro touch. Sotto: dettaglio della colonna Convoy Centro con struttura estraibile verniciata brown e interno in nobilitato grigio perla, ante in STM champagne con profilo maniglia e sagoma in anodizzato champagne.

To the right: close up of the door in LCT super white with handle profile, profile and lateral vertical spacer in anodized champagne. Top and finishing sides in Inalco MDi® calacatta oro touch. Below: close up of the tall unit Convoy Centro with painted brown pull-out structure and interior in grey perla melamine, doors in STM champagne with handle profile and profile in anodized champagne.

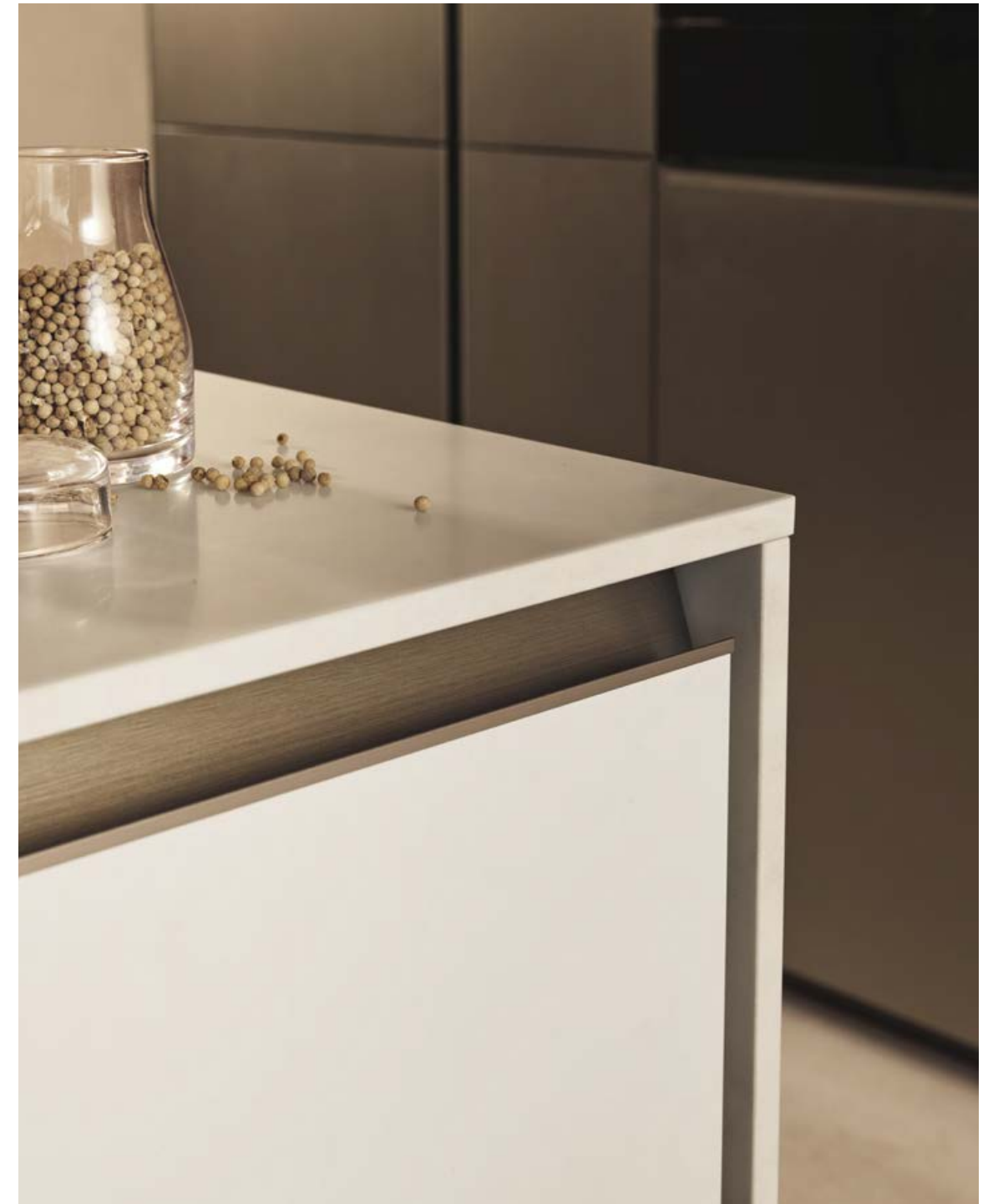



**ALEA PRO**  
Design R&D Poliform

**Basi - isola p 640/410,  
a parete p 740**

Strutture: nobilitato grigio perla.  
Isola: ante LCT super white; top, piano a sbalzo Planar e fianchi: Inalco MDi® calacatta oro touch, spessore 12 mm.  
A parete: ante STM champagne; top e fianchi: laminato tuttocolore touch super white, spessore 12 mm.  
Profili maniglia, sagome e distanziatori verticali: anodizzato champagne.  
Zoccoli: laccato opaco champagne.

**Sistema modulare Infinity**

Modulo aspirante luminoso e due moduli luminosi.  
Finitura acciaio scotch brite e vetro extralight.

**Pensili vetrina PR24 p 410/510**

Strutture: nobilitato olmo smoke.  
Ante vetrina PR24: profilo anodizzato champagne e vetro riflettente fumé.  
Fianchi di finitura: laccato opaco champagne, spessore 6 mm.

**Deep Shaker p 160**

Struttura: anodizzato moka.  
Schienale: nobilitato olmo smoke.  
Ante a ribalta, tubi: laccato gofrato moka.

**Colonne p 640**

Strutture: nobilitato grigio perla.  
Ante: STM champagne, profilo maniglia e sagoma anodizzato champagne.  
Distanziatori verticali: anodizzato champagne.  
Zoccoli: laccato opaco champagne.

**Complementi**

Sgabello Ventura: olmo nero, pelle non sfoderabile Silk 10 terracotta.

**Base units - island d 25 1/4"/16 1/4",  
to the wall d 29 1/4"**

Structures: grey perla melamine.  
Island: doors LCT super white; top, jutting-out top Planar and sides: Inalco MDi® calacatta oro touch, thickness 1/2".  
To the wall: doors STM champagne; top and sides: laminate tuttocolore touch super white, thickness 1/2".  
Handle profiles, profiles and vertical spacers: anodized champagne.  
Plinths: champagne mat lacquer.

**Modular system Infinity**

Lighted suction module and two lighted modules.  
Finishing steel scotch brite and extra light glass.

**Showcase wall units PR24 d 16 1/4"/20"**

Structures: smoke elm melamine.  
Showcase doors PR24: profilo anodizzato champagne and fumé reflecting glass.  
Finishing sides: champagne mat lacquer, thickness 1/4".

**Deep Shaker d 6 1/4"**

Structure: anodized moka.  
Back: smoke elm melamine.  
Flap door, bars: moka embossed lacquer.

**Tall units d 25 1/4"**

Structures: grey perla melamine.  
Doors: STM champagne, handle profile and profile anodized champagne.  
Vertical spacers: anodized champagne.  
Plinths: champagne mat lacquer.

**Accessories**

Ventura stool: black elm, non-removable leather Silk 10 terracotta.

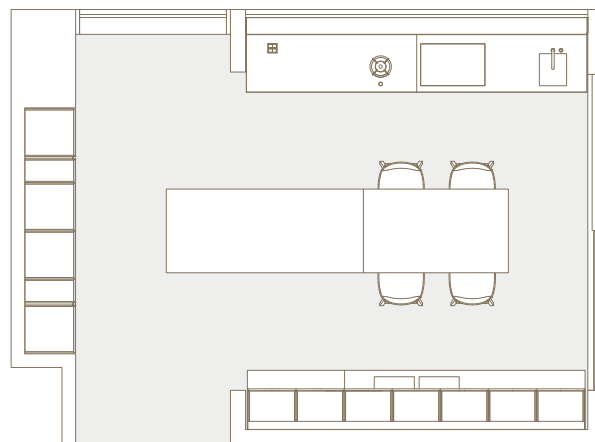
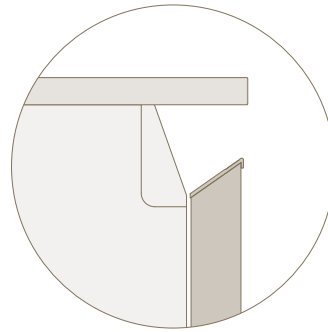

**Isola  
Island**

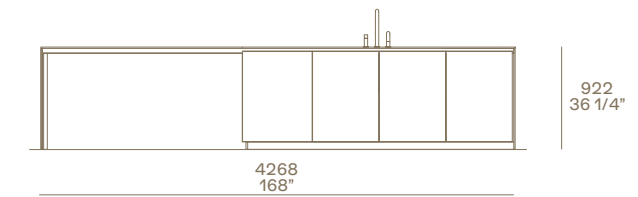
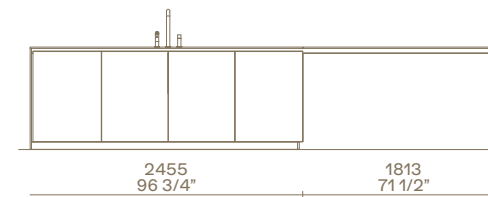

**Basi a parete  
Wall base units**

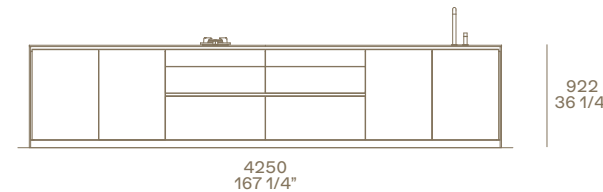

**Basi a parete, pensili, Deep Shaker  
Wall base units, wall units, Deep Shaker**

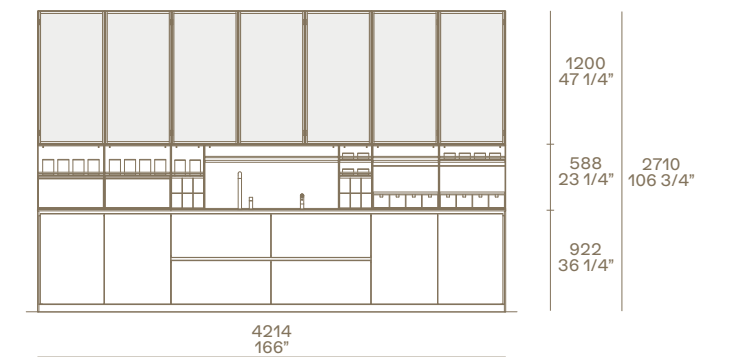

**Colonne  
Tall units**

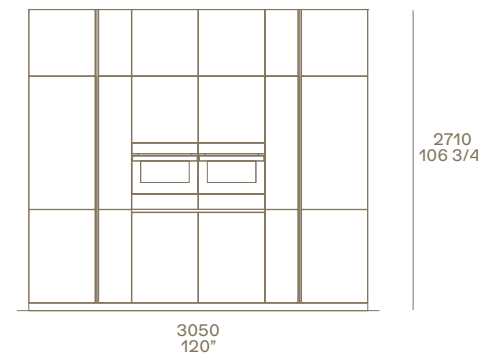

**Ventura  
Design Rodrigo Torres**

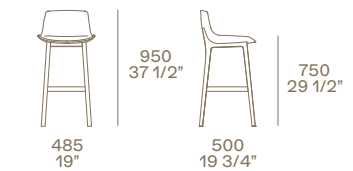



- 1 Sistema modulare Infinity, personalizzato Poliform.
- 2 Presa elettrica a scomparsa.
- 3 Piano cottura a gas Pitt Cooking® con manopola personalizzata Poliform.
- 4 Piano cottura a induzione, incasso filotop.
- 5 Lavelli integrati in acciaio per piani in laminato tuttocolore.

- 6 Attrezzatura in noce canaletto e anodizzato moka.
- 7 Piano a sbalzo Planar, mm 1813×1044.
- 8 Fianco Ala.
- 9 Pensili con ante vetrina PR24, apertura con profilo inferiore, ripiani in vetro fumé con telaio anodizzato nero.

- 10 Schienale modulare Deep Shaker con configurazione a ponte in corrispondenza dei livelli.
- 11 Colonne con forni e frigoriferi con ante ad apertura battente ed estrattori.
- 12 Colonna Convoy Centro con struttura estraibile.

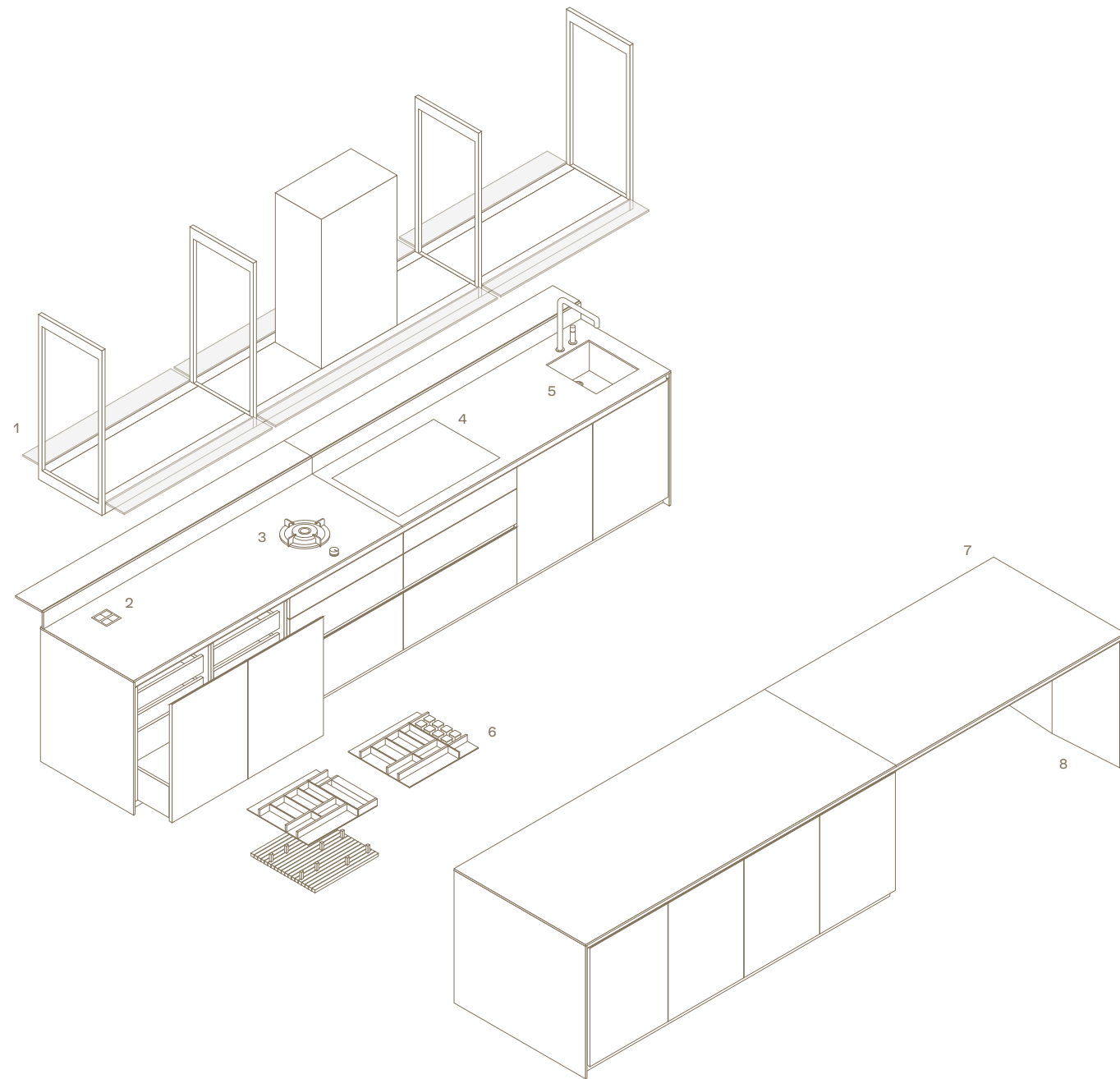

- 1 Modular system Infinity, personalized Poliform.
- 2 Retractable electrical socket.
- 3 Gas hob Pitt Cooking® with Poliform personalized control.
- 4 Induction hob, flush built-in.
- 5 Integrated sinks in steel for tops in laminated all-color.

- 6 Equipment in walnut canaletto and anodized moka.
- 7 Jutting-out top Planar, 71 1/2"x41".
- 8 Side Ala.
- 9 Wall units with showcase doors PR24, opening with lower profile, shelves in fumé glass with anodized black frame.

- 10 Modular back Deep Shaker with bridge configuration in correspondence of the sinks.
- 11 Tall units with ovens and refrigerators with leaf doors and pull-out storage baskets.
- 12 Tall unit Convoy Centro with pull-out structure.

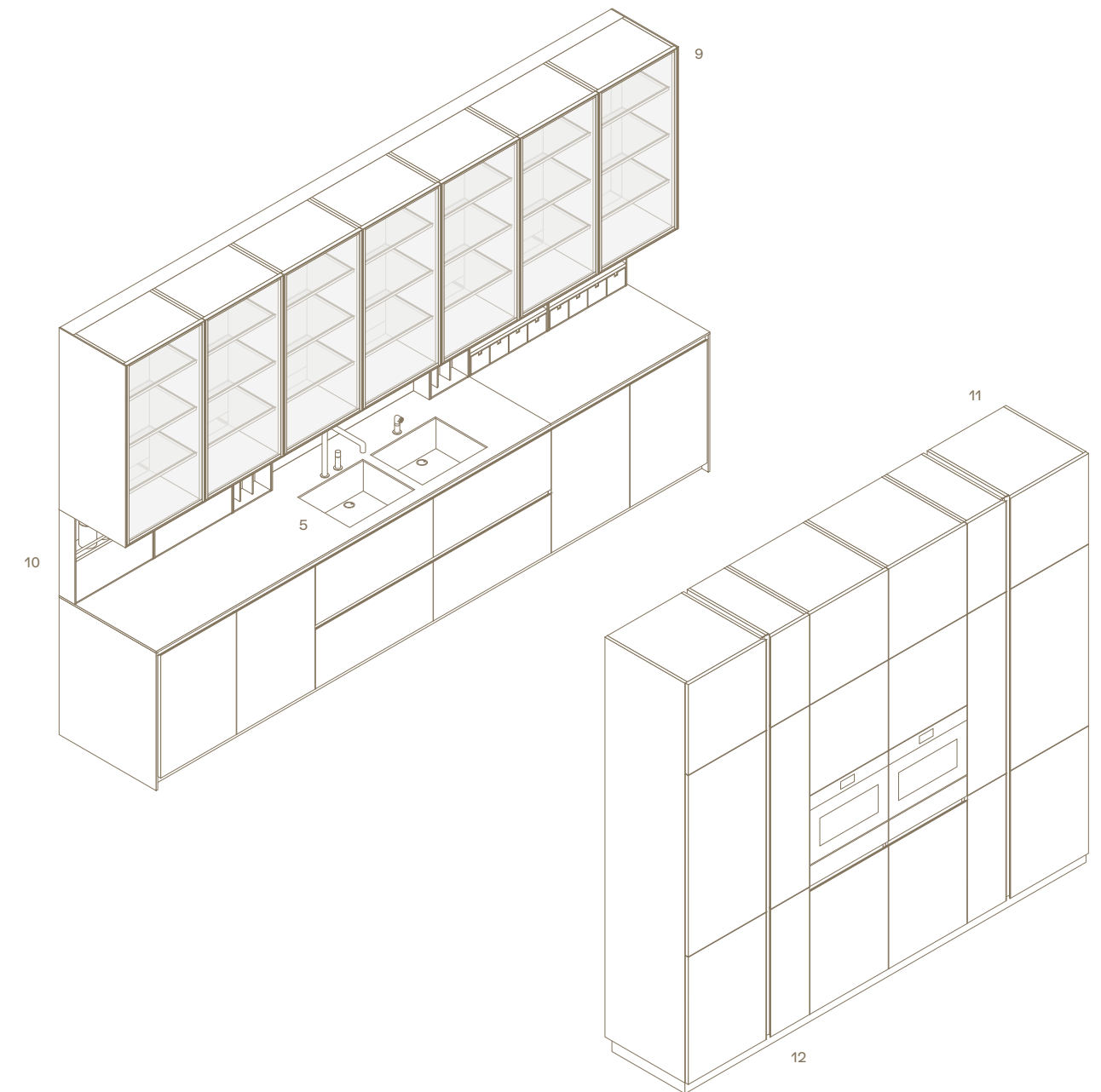











Qui e nelle pagine precedenti: basi con ante ed estrattori in rovere gold con profilo maniglia e sagoma in anodizzato moka, fianchi di finitura in rovere gold e top in laminato tuttocolore touch acciaio. In appoggio sulle basi, snack Lama con piano in olmo nero, gamba e supporto in laccato goffrato moka. Sgabelli Sophie Lite in olmo nero con poggiatesta in brown nickel opaco e seduta rivestita in tessuto sfoderabile Arcadia 05 bronzo. Pensili con ante in LCT silver gray. Sotto ai pensili, Deep Shaker in anodizzato moka e schienali in rovere gold con configurazione a ponte per elettrodomestici. Colonne con ante ed estrattori in LCT silver gray con profilo maniglia e sagoma in anodizzato moka, ante vetrina PR24 in anodizzato moka e vetro riflettente fumé con struttura in rovere gold e illuminazione a led integrata. Tavolino Dama in massello noce canaletto.

Here and previous pages: base units with doors and pull-out baskets in gold oak with handle profile and profile in anodized moka, finishing sides in gold oak and top in laminate tuttocolore touch acciaio. On the base units, snack Lama with top in black elm, leg and support in moka embossed lacquer. Sophie Lite stools in black elm with footrest in mat brown nickel and seat covered in removable fabric Arcadia 05 bronzo. Wall units with doors in LCT silver gray. Under the wall units, Deep Shaker in anodized moka and backs in gold oak with bridge configuration for electrical appliances. Tall units with doors and pull out baskets in LCT silver gray with handle profile and profile in anodized moka, showcase doors PR24 in anodized moka and fumé reflecting glass with structure in gold oak and integrated led lighting. Dama coffee table in solid walnut canaletto.







A sinistra: dettaglio del top con lavello integrato in laminato tuttocolore touch acciaio. Piano cottura a induzione con cappa a scomparsa Fly personalizzata Poliform e pannello sottopensile in laccato goffrato silver gray con canalina multiled posteriore. Sotto: dettaglio della base con top in laminato tuttocolore touch acciaio, anta in rovere gold con profilo maniglia e sagoma in anodizzato moka.

To the left: close up of the top with integrated sink in laminate tuttocolore touch acciaio. Induction hob with retractable cooker hood Fly personalized Poliform and panel under wall unit in silver gray embossed lacquer with rear multiled channel. Below: close up of the base unit with top in laminate tuttocolore touch acciaio, door in gold oak with handle profile and profile in anodized moka.









Nella pagina precedente: pensili con ante in LCT silver gray. Sotto ai pensili, Deep Shaker in anodizzato moka e schienali in rovere gold con configurazione a ponte per elettrodomestici, porta tablet, porta coltelli e cassettini in noce canaletto, barattoli in ceramica e vetro con coperchi noce canaletto. A destra: dettaglio dei cesti estraibili LeMans II in verniciato brown per base ad angolo, ante in rovere gold con profilo maniglia e sagoma in anodizzato moka, top in laminato tuttocolore touch acciaio. Sotto: dettaglio del lavello integrato al top in laminato tuttocolore touch acciaio.

Previous page: wall units with doors in LCT silver gray. Under the wall units, Deep Shaker in anodized moka and backs in gold oak with bridge configuration for electrical appliances, tablet holder, knives holder and small drawers in walnut canaletto, ceramic and glass jars with walnut canaletto lids. To the right: close up of the pull-out trays LeMans II in painted brown for corner base units, doors in gold oak with handle profile and profile in anodized moka, top in laminate tuttocolore touch acciaio. Below: close up of the sink integrated in the top in laminate tuttocolore touch acciaio.







Qui e nella pagina successiva: basi con ante ed estrattori in rovere gold, profilo maniglia e sagoma in anodizzato moka, cassetto interno in alluminio anodizzato naturale con attrezzatura in laminato military touch. Top in laminato tuttocolore touch acciaio. Piano cottura a induzione. Deep Shaker in anodizzato moka e schienali in rovere gold con configurazione a ponte per elettrodomestici, cassettoni in noce canaletto e barattoli in ceramica con coperchi noce canaletto. Pensili con ante in LCT silver gray. Nella successiva: in appoggio sulle basi, snack Lama con piano in olmo nero, gamba e supporto in laccato goffrato moka. Sgabelli Sophie Lite in olmo nero con poggiatesta in brown nickel opaco e seduta rivestita in tessuto sfoderabile Arcadia 05 bronzo.

Here and following page: base units with doors and pull-out baskets in gold oak, handle profile and profile in anodized moka, inner drawer in natural anodized aluminium with equipment in laminate military touch. Top in laminate tuttocolore touch acciaio. Induction hob. Deep Shaker in anodized moka and backs in gold oak with bridge configuration for electrical appliances, small drawers in walnut canaletto, ceramic and glass jars with walnut canaletto lids. Wall units with doors in LCT silver gray. Next page: on the base units, snack Lama with top in black elm, leg and support in moka embossed lacquer. Sophie Lite stools in black elm with footrest in mat brown nickel and seat covered in removable fabric Arcadia 05 bronzo.







In questa pagina: colonne con ante ed estrattori in LCT silver gray con profilo maniglia e sagoma in anodizzato moka. Ante vetrina PR24 in anodizzato moka e vetro riflettente fumé con struttura interna in rovere gold, ripiani in vetro fumé con telaio in anodizzato nero e illuminazione a led integrata. Sgabello Sophie Lite in olmo nero con poggiatesta in brown nickel opaco e seduta rivestita in tessuto sfoderabile Arcadia 05 bronzo.

This page: tall units with doors and pull-out baskets in LCT silver gray with handle profile and profile in anodized moka. Showcase doors PR24 in anodized moka and fumé reflecting glass with inner structure in gold oak, shelves in fumé glass with frame in anodized black and integrated led lighting. Sophie Lite stool in black elm with footrest in mat brown nickel and seat covered in removable fabric Arcadia 05 bronze.







A sinistra: dettaglio della colonna con interno in rovere gold, attrezzato con cassettera in laminato opaco touch nero, ripiani in vetro fumé con telaio in anodizzato nero e illuminazione a led integrata. Sotto: dettaglio dell'anta vetrina PR24 in anodizzato moka e vetro riflettente fumé con maniglia integrata nel montante del telaio.

To the left: close up of the tall unit with interior in gold oak, equipped with chest of drawers in mat laminate touch nero, shelves in fumé glass with anodized black frame and integrated led light. Below: close up of the showcase door PR24 in anodized moka and fumé reflecting glass with integrated handle in the vertical frame.





In questa pagina: snack Lama con piano in olmo nero, gamba e supporto in laccato goffrato moka. Sgabelli Sophie Lite in olmo nero con poggiatesta in brown nickel opaco e seduta rivestita in tessuto sfoderabile Arcadia 05 bronzo.

This page: snack Lama with top in black elm, leg and support in moka embossed lacquer. Sophie Lite stools in black elm with footrest in mat brown nickel and seat covered in removable fabric Arcadia 05 bronzo.





In questa pagina: sgabelli Seattle con seduta e gambe rivestite in cuoio non sfoderabile 29 tortora. Basi in rovere gold con profilo maniglia e sagoma in anodizzato moka, snack Lama con piano in olmo nero, gamba e supporto in laccato goffrato moka. Sotto: dettaglio che evidenzia la lavorazione con broguering dello sgabello Seattle.

This page: Seattle stools with seat and legs covered in non-removable hide 29 tortora. Base units in gold oak with handle profile and profile in anodized moka, snack Lama with top in black elm, leg and support in moka embossed lacquer. Below: close up which highlights the broguering manufacturing of the Seattle stool.





**ALEA PRO**  
Design R&D Poliform

**Basi p 740**  
Strutture: nobilitato grigio perla.  
Ante: rovere gold, profilo maniglia e sagoma anodizzato moka.  
Top: laminato tuttocolore touch acciaio, spessore 20 mm.  
Fianchi di finitura: rovere gold, spessore 20 mm.  
Zoccoli: laccato goffrato moka.

**Snack Ø 1400**  
Lama: piano olmo nero, gamba e supporto in laccato goffrato moka.

**Pensili p 410/510**  
Strutture: nobilitato grigio perla.  
Ante: LCT silver gray.  
Fianchi di finitura: laccato goffrato silver gray, spessore 6 mm.

**Deep Shaker p 160**  
Strutture: anodizzato moka.  
Schienale: rovere gold.  
Ripiani: laccato goffrato moka.  
Tubi: acciaio scotch brite.

**Colonne p 640**  
Strutture: nobilitato grigio perla.  
Ante: LCT silver gray, profilo maniglia e sagoma anodizzato moka.  
Strutture vetrina: rovere gold.  
Ante vetrina PR24: profilo anodizzato moka e vetro riflettente fumé.  
Zoccoli: laccato goffrato moka.

**Complementi**  
Sgabello Sophie Lite: olmo nero, tessuto sfoderabile Arcadia 05 bronzo.  
Sgabello Seattle: cuoio non sfoderabile 29 tortora.

**Base units d 29 1/4"**  
Structures: grey perla melamine.  
Doors: gold oak, handle profile and profile anodized moka.  
Top: laminate tuttocolore touch acciaio, thickness 3/4".  
Finishing sides: gold oak, thickness 3/4".  
Plinths: moka embossed lacquer.

**Snack Ø 55"**  
Lama: black elm top, leg and support in moka embossed lacquer.

**Wall units d 16 1/4"/20"**  
Structures: grey perla melamine.  
Doors: LCT silver gray.  
Finishing sides: silver gray embossed lacquer, thickness 1/4".

**Deep Shaker d 6 1/4"**  
Structures: anodized moka.  
Back: gold oak.  
Shelves: moka embossed lacquer.  
Bars: steel scotch brite.

**Tall units d 25 1/4"**  
Structures: grey perla melamine.  
Doors: LCT silver gray, handle profile and profile anodized moka.  
Showcase structures: gold oak.  
Showcase doors PR24: anodized moka profile and fumé reflecting glass.  
Plinths: moka embossed lacquer.

**Accessories**  
Sophie Lite stool: black elm, removable fabric Arcadia 05 bronzo.  
Seattle stool: non-removable hide 29 tortora.

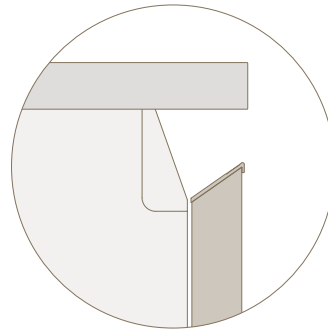

**Basi, pensili, Deep Shaker**  
**Base units, wall units, Deep Shaker**

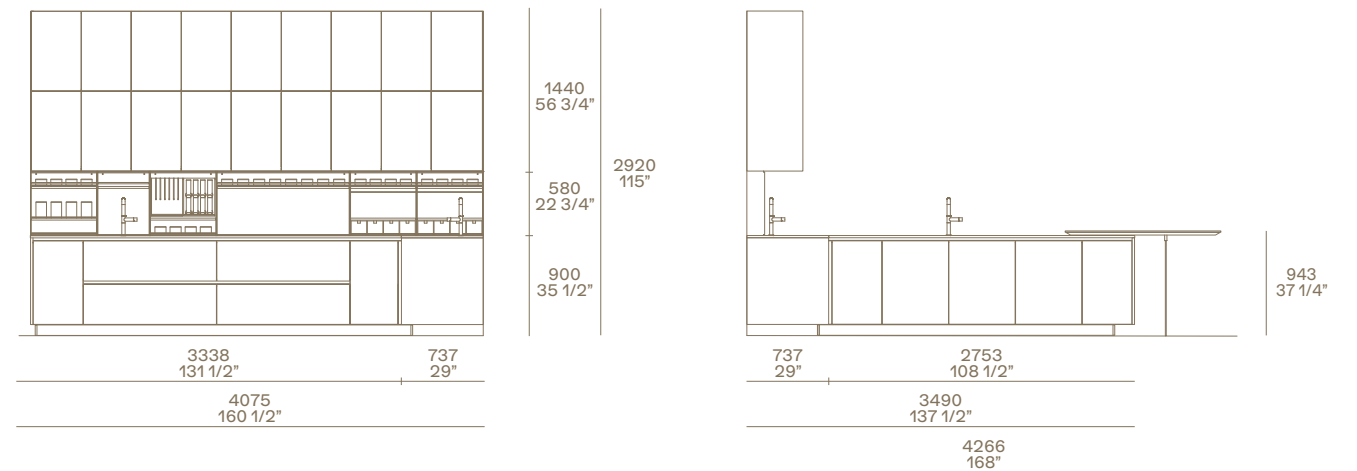

**Colonne**  
**Tall units**

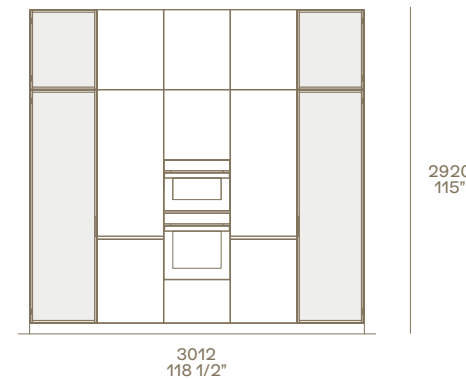

**Sophie Lite**  
Design Emmanuel Gallina

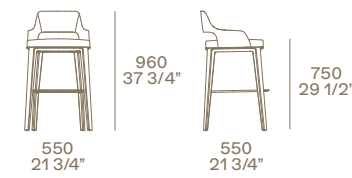

**Seattle**  
Design Jean-Marie Massaud

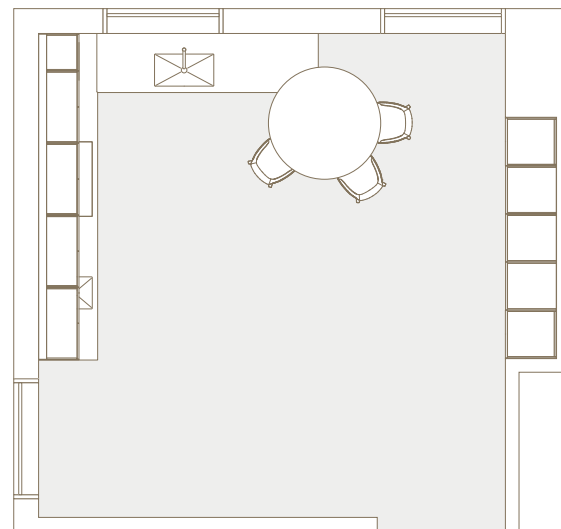
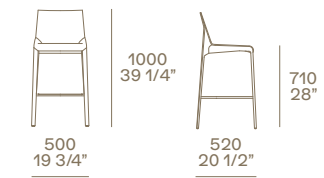



- 1 Pensili con ante battenti, apertura tip-on e con profilo inferiore.
- 2 Cappa a scomparsa Fly, personalizzata Poliform.
- 3 Schienale modulare Deep Shaker con configurazioni a ponte in corrispondenza del lavello e del piano cottura.

- 4 Lavelli integrati in laminato tuttocolore touch acciaio con fondo in acciaio.
- 5 Piano cottura a induzione, incasso filotop.
- 6 Attrezzatura cassette in laminato military touch.
- 7 Presa elettrica a scomparsa.

- 8 Snack Lama, diametro 1400 mm.
- 9 Colonne con ante vetrina PR24, cassetiera in laminato opaco touch nero, ripiani in vetro fumé con telaio in anodizzato nero.
- 10 Colonne con forni e frigoriferi con ante ad apertura battente ed estrattori.

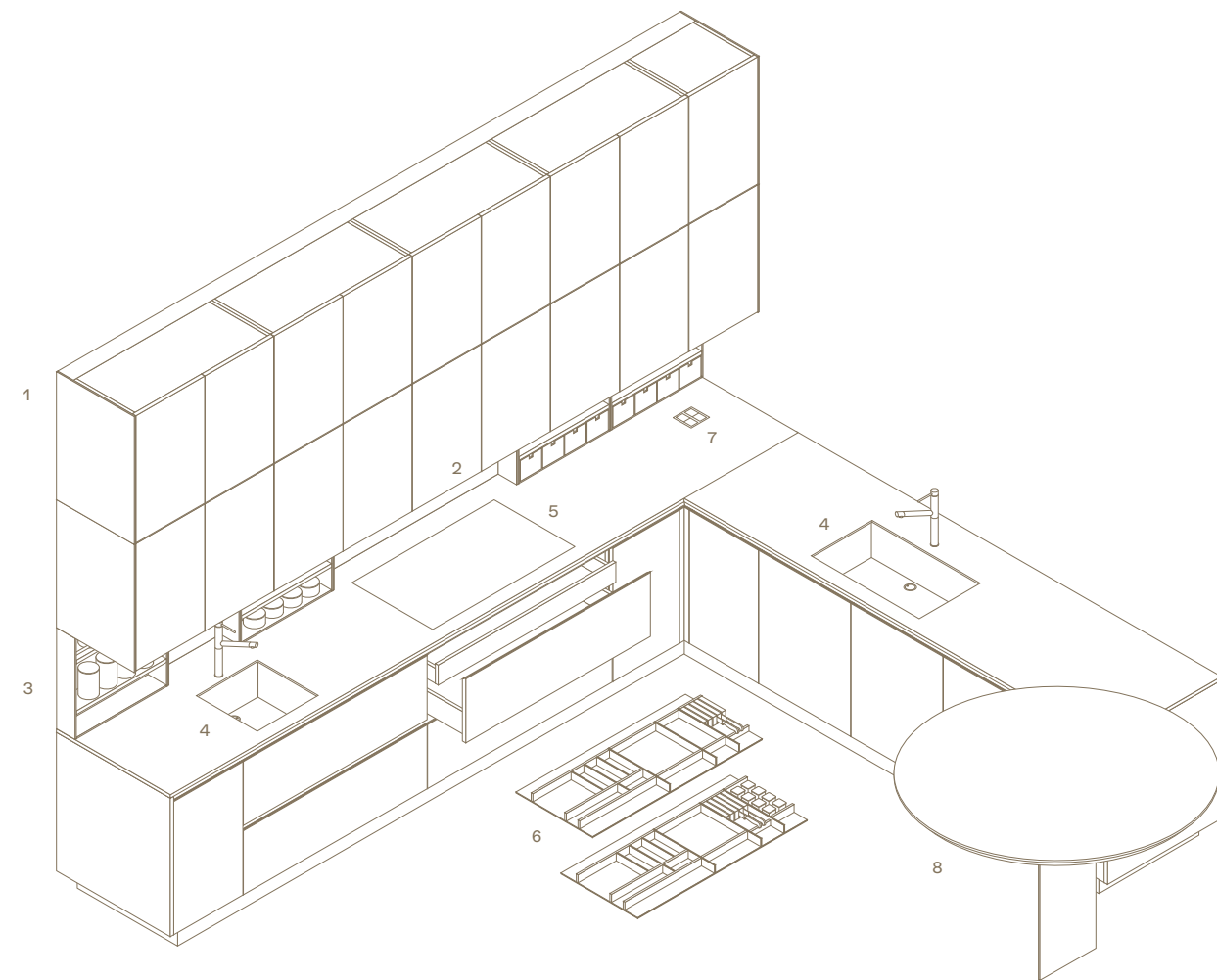

- 1 Wall units with leaf doors, opening with tip-on and with lower profile.
- 2 Retractable cooker hood Fly, personalized Poliform.
- 3 Modular back Deep Shaker with bridge configurations in correspondence of the sink and the hob.

- 4 Integrated sinks in laminate tuttocolore touch acciaio with steel bottom.
- 5 Induction hob, flush built-in.
- 6 Drawers' equipment in laminate military touch.
- 7 Retractable electrical socket.

- 8 Snack Lama, diameter 55".
- 9 Tall units with showcase doors PR24, chest of drawers in laminate mat touch nero, shelves in fumé glass with anodized black frame.
- 10 Tall units with ovens and refrigerators with leaf doors and pull-out baskets.

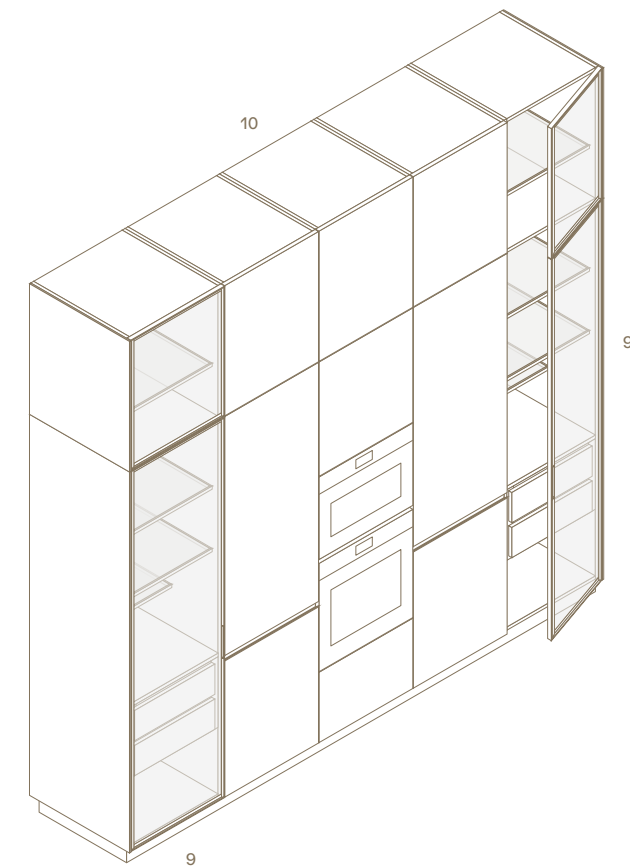



TECHNICAL DATA

CARATTERISTICHE DEL MODELLO  
CHARACTERISTICS OF THE MODEL

58

VETRINE  
SHOWCASES

60

FINITURE  
FINISHINGS

62



## ALEA PRO

Design R&D Poliform

### Spessore anta

22 mm.

Bordo apertura rastremato 55°.

### Finiture anta

Laminato opaco 6 colori.

Nobilitato 7 finiture.

Laminato opaco touch 6 colori.

LCT 3 colori.

Laccato goffrato 23 colori.

STM 3 colori.

8 essenze.

Laccato metallico 4 colori.

Laccato lucido 11 colori.

Laminato satinato touch 3 colori.

Vetro satinato 6 colori.

Vetro lucido 6 colori.

Inalco MDi® 2 colori.

Acciaio scotch brite.

Acciaio PVD 2 colori.

Ante in vetro e in Inalco MDi® con telaio di supporto, incluso profilo maniglia, in alluminio solo anodizzato moka e pannello di chiusura posteriore in tinta. Ante in acciaio con bordo rastremato in corrispondenza dell'apertura (no profilo maniglia).

### Finiture profilo maniglia

Anodizzato naturale.

Anodizzato champagne.

Anodizzato moka.

### Door thickness

22 mm - 3/4".

55° chamfered opening edge.

### Door finishings

Mat laminate 6 colours.

Melamine 7 finishings.

Mat laminate touch 6 colours.

LCT 3 colours.

Embossed lacquer 23 colours.

STM 3 colours.

8 woods.

Metal lacquer 4 colours.

Glossy lacquer 11 colours.

Satin laminate touch 3 colours.

Etched glass 6 colours.

Glossy glass 6 colours.

Inalco MDi® 2 colours.

Steel scotch brite.

PVD steel 2 colours.

Doors in glass and in Inalco MDi® with supporting frame, including handle profile only available in moka anodized aluminium and rear closing panel in matching colour. Doors in steel with chamfered edge in correspondence of the opening (without handle profile).

### Handle profile finishings

Anodized natural.

Anodized champagne.

Anodized moka.

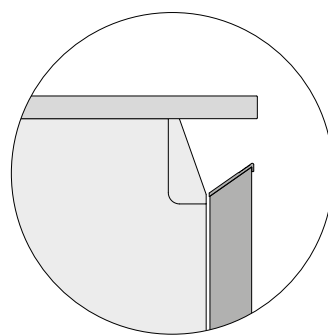

## VETRINE SHOWCASES

### PR24

Spessore 24 mm.  
Anta in vetro riflettente 5059 fumé con telaio in alluminio anodizzato champagne o moka.  
Per basi anta con telaio superiore sagomato a 55° come anta Alea Pro.  
Per pensili apertura con profilo inferiore.  
Per colonne apertura con maniglia integrata verniciato moka o champagne.  
Per elementi sopra colonna apertura tip-on.  
Thickness 24 mm - 1".  
Door in fumé reflecting glass 5059 with frame in moka anodized aluminium or champagne.  
For base units, door with 55° shaped upper frame like Alea Pro door.  
For wall units, opening with lower profile.  
For tall units, opening with integrated handle painted moka or champagne.  
For elements above tall unit, tip-on opening.



### PR19

Spessore 26 mm.  
Anta in vetro riflettente 5051 bronzato con telaio in alluminio verniciato bronzo.  
Per pensili apertura con profilo inferiore o apertura tip-on.  
Thickness 26 mm - 1".  
Door in bronzed reflecting glass 5051 with frame in bronzo painted aluminium.  
For wall units, opening with lower profile or tip-on opening.



### PR22

Spessore 20 mm.  
Anta in vetro riflettente 5059 fumé con telaio in alluminio anodizzato nero.  
Per pensili apertura con profilo inferiore.  
Per colonne apertura con distanziale o con maniglia integrata verniciato nero.  
Per elementi sopra colonna apertura con distanziale o apertura tip-on.  
Thickness 20 mm - 3/4".  
Door in fumé reflecting glass 5059 with black anodized aluminium frame.  
For wall units, opening with lower profile.  
For tall units, opening with spacer or with black painted integrated handle.  
For elements above tall unit, opening with spacer or tip-on opening.



### PR21

Spessore 26 mm.  
Anta in vetro riflettente 5059 fumé con telaio in alluminio anodizzato moka.  
Per pensili apertura con profilo inferiore.  
Per colonne apertura con maniglia integrata verniciato moka.  
Per elementi sopra colonna apertura tip-on.  
Thickness 26 mm - 1".  
Door in fumé reflecting glass 5059 with moka anodized aluminium frame.  
For wall units, opening with lower profile.  
For tall units, opening with moka painted integrated handle.  
For elements above tall unit, tip-on opening.





## FINITURE FINISHINGS

### Struttura Structure



G2 nobilitato  
grigio perla  
grey perla melamine



G3 nobilitato  
grigio lavagna  
grey lavagna melamine

### Profili maniglia, sagome e distanziali verticali Handle profiles, profiles and vertical spacers



anodizzato naturale  
anodized natural



anodizzato champagne  
anodized champagne

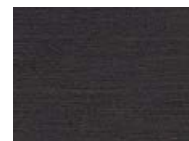

anodizzato moka  
anodized moka

### Zoccoli Plinths



anodizzato naturale  
anodized natural

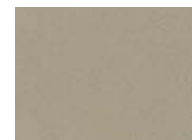

champagne  
laccato opaco  
mat lacquer



moka  
laccato goffrato  
embossed lacquer

### Interno vetrine essenza Showcases wooden inner structure



rovere gold  
gold oak



rovere cenere  
cenere oak



rovere tinto grigio  
grey oak painted



rovere spessart  
spessart oak



olmo  
elm



olmo nero  
black elm



noce c.  
walnut c.



noce nazionale  
italian walnut

### Interno vetrine nobilitato Showcases melamine inner structure



nobilitato olmo smoke  
smoke elm melamine

Interno in essenza e nobilitato olmo smoke, solo per basi con anta vetrina PR24 o pensili, colonne ed elementi sopra colonna con ante vetrina.

Interior in wood and melamine smoke elm, only available for base units with showcase door PR24 or wall units, tall units and elements above tall unit with showcase door.

FINITURE ANTA  
DOOR FINISHINGS

**Laccato goffrato**  
**Embossed lacquer**

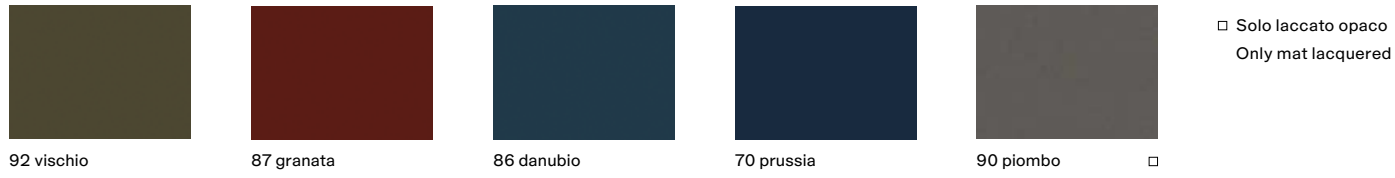
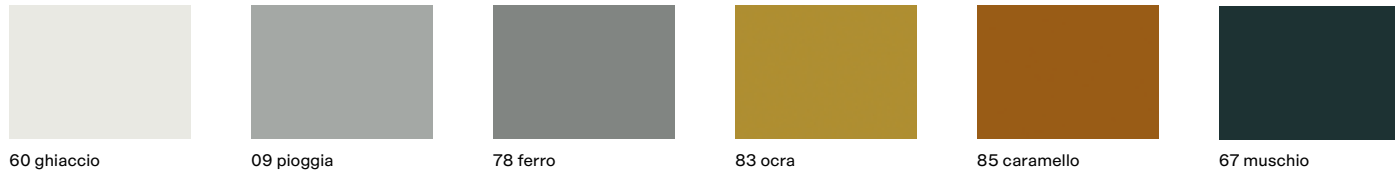
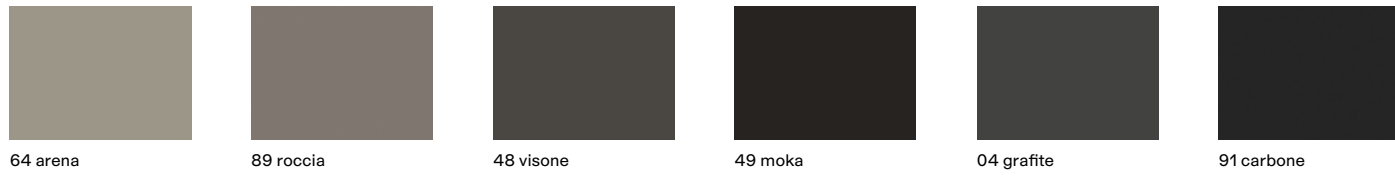
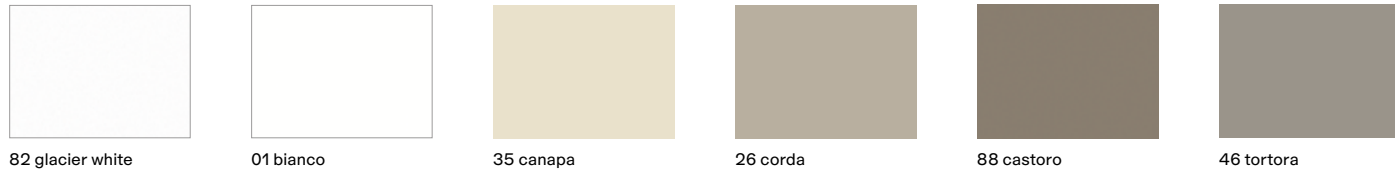

□ Solo laccato opaco  
Only mat lacquered

**STM**  
**STM**



**Laccato metallico**  
**Metal lacquer**

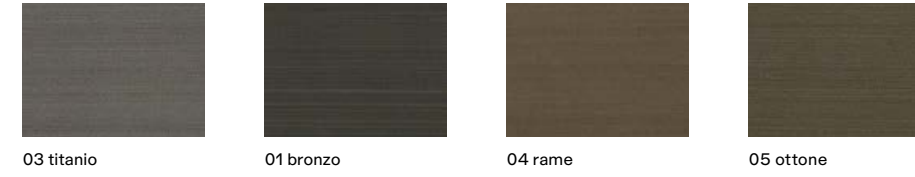

**Laccato lucido**  
**Glossy lacquer**

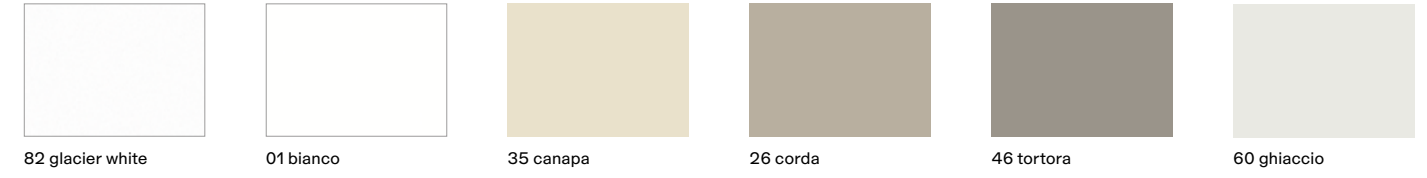

**Acciaio**  
**Steel**



**Acciaio PVD**  
**PVD steel**

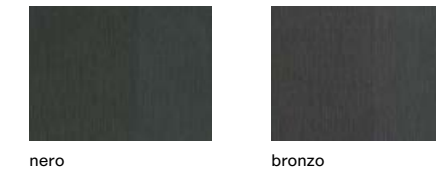



FINITURE ANTA  
DOOR FINISHINGS

**Essenza  
Wood**



rovere gold  
gold oak



rovere cenere  
cenere oak



rovere tinto grigio  
grey oak painted



rovere spessart  
spessart oak



olmo  
elm



olmo nero  
black elm



noce c.  
walnut c.



noce nazionale  
italian walnut

**Inalco MDi®  
Inalco MDi®**



06 carrara touch



05 stone brown

**Vetro satinato  
Frosted glass**

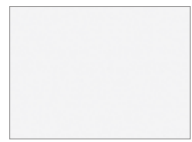

2301 bianco  
extrachiaro - extralight

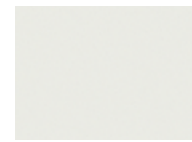

2373 ghiaccio  
extrachiaro - extralight

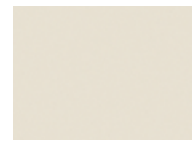

1335 canapa



1364 arena



1304 grafite



1303 nero

**Vetro lucido  
Glossy glass**

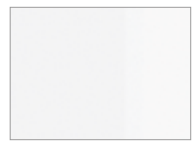

2201 bianco  
extrachiaro - extralight

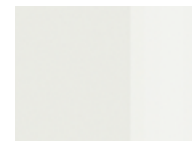

2273 ghiaccio  
extrachiaro - extralight



1235 canapa



1264 arena



1204 grafite



1203 nero

**Vetro riflettente  
Reflecting glass**



5059 fumé  
solo per vetrina PR24  
only for showcase PR24

**Laminato opaco  
Mat laminate**



U1 super white



01 bianco



35 canapa



U3 sand

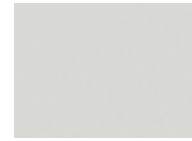

U2 silver gray



04 grafite

**Laminato opaco touch  
Mat laminate touch**



F4 super white touch



F1 bianco touch



F3 castoro touch



F6 ardesia touch

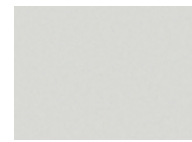

F5 silver gray touch



F2 nero touch

**Laminato satinato touch  
Satin laminate touch**



F7 acciaio



F8 alluminio



F9 champagne

**LCT  
LCT**



F4 super white

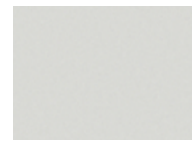

F5 silver gray



F7 sand

**Nobilitato  
Melamine**



LC larice sabbia  
larch sabbia



L9 rovere smoke  
smoke oak

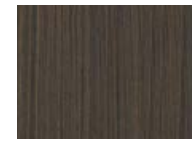

LE larice tabacco  
larch tabacco



LF larice nero  
larch nero

**Nobilitato silk  
Silk melamine**



LG perla



LD bronzo



LH grey

FINITURE TOP  
TOP FINISHINGS

**Quarzite lucida**  
Glossy composite stone



**Quarzite micropallinata**  
Micro-blasted composite stone



**Pietra**  
Stone



**Marmo levigato**  
Mat marble

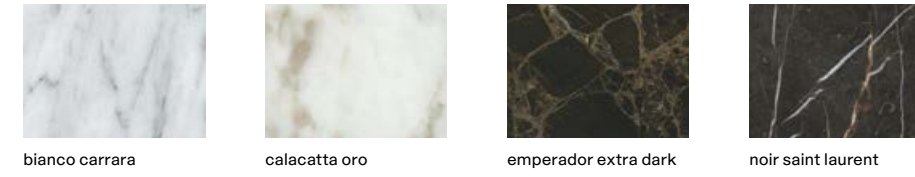

**Marmo lucido**  
Glossy marble



**Inalco MDi®**  
Inalco MDi®

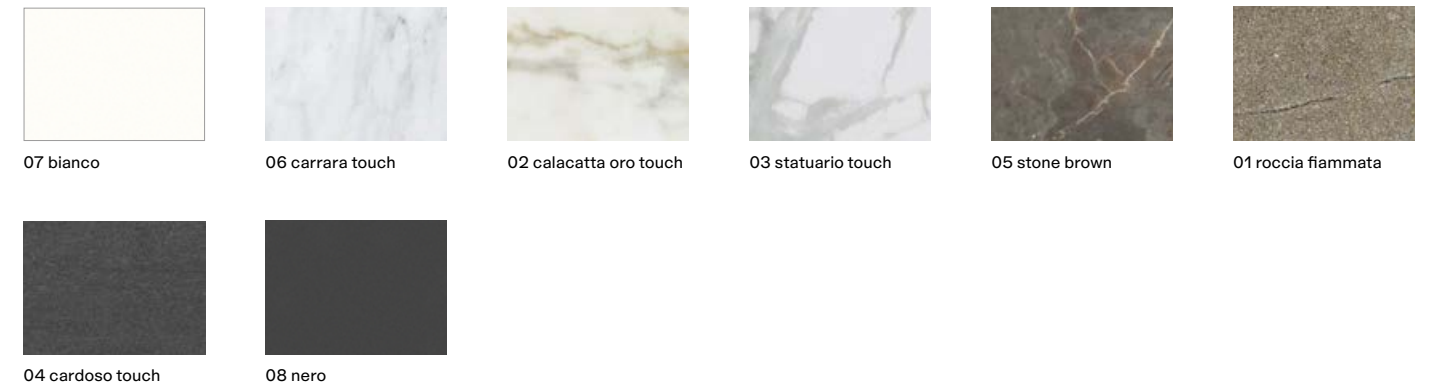



FINITURE TOP  
TOP FINISHINGS

**Acciaio  
Steel**



scotch brite



steelmatt



dark

**Dekton  
Dekton**

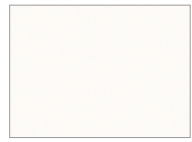

05 bianco



03 grigio cemento



04 grigio Londra



02 tortora



01 nero

**DuPont Corian®  
DuPont Corian®**



93 glacier white

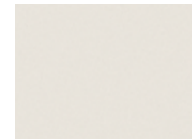

81 bone



96 pearl gray



95 elegant gray



97 silver gray



90 deep cloud

**Laminato tuttocolore  
Tuttocolore laminate**



U1 super white



01 bianco



35 canapa



U3 sand

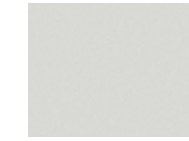

U2 silver gray



04 grafite

**Laminato tuttocolore touch  
Tuttocolore laminate touch**



F4 super white touch



F1 bianco touch



F3 castoro touch



F6 ardesia touch

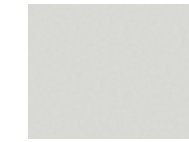

F5 silver gray touch



F2 nero touch



F7 acciaio touch



F8 alluminio touch



F9 champagne touch

**Essenza  
Wood**



rovere gold  
gold oak



rovere cenere  
cenere oak



rovere tinto grigio  
grey oak painted



rovere spessart  
spessart oak



olmo  
elm



olmo nero  
black elm



noce c.  
walnut c.



noce nazionale  
italian walnut

Sui top in essenza non è possibile prevedere incassi per piani cottura e lavelli.

Worktops in wood are not available with cut outs for built-in hobs and sinks.

**Poliform Spa**

via Montesanto 28  
Casella postale n. 1  
22044 Inverigo (CO) Italy  
t +39 031 6951  
f +39 031 699444  
info@poliform.it  
poliform.it

**Poliform realizza tutte le sue collezioni in Italia usando componenti e materie prime selezionate.**

**All the Poliform collections are manufactured 100% in Italy using top-class components and materials.**

Poliform si riserva il diritto di apportare, senza preavviso, ogni modifica mirata al miglioramento funzionale e qualitativo dei propri prodotti. Testi e disegni presenti in questo stampato hanno scopo divulgativo; per ogni aspetto tecnico e dimensionale fare riferimento ai listini aziendali e relativi aggiornamenti. I campioni di colori e materiali hanno valore indicativo.

Poliform reserves the rights at all time to apply modifications for the functional or qualitative improvement of its products. Texts and drawings present in this brochure have a divulgative purpose; for every technical and dimensional aspect please refer to the company's price lists and their relative updatings. The colour and material samples have an indicative value.



2018 Adi Compasso D'oro  
Career Award